

User Guidance Notes

Submission of HP data

1 Introduction

These Guidance Notes have been prepared to explain how to submit data to the Energy Networks Association (ENA) for inclusion in the ENA Heat Pump (HP) and Electric Vehicle Charge Point (EVCP) Databases.

These Guidance Notes should be read in conjunction with the Low Carbon Technologies (LCT) Application Form and associated Process Flow Chart.

2 Scope

It is assumed that the equipment is intended for connection to a Low Voltage (LV) electricity distribution system; values quoted in amperes (A) assume this.

3 Purpose of Databases

The purpose of the ENA Heat Pump (HP) and Electric Vehicle Charge Point (EVCP) Databases are to simplify the application process for the connection of LCT to Distribution Network Operator (DNO) or Independent Distribution Network Operator (IDNO) electricity distribution networks.

HPs and EVCPs are viewed as equipment that have the potential to disturb the quality of voltage provided to DNO/IDNO customers. The intention is to hold the technical information in a database that is necessary for DNOs/IDNOs to design connection to their networks. This allows for customers to use a simplified application form that refers to the make and model proposed, reducing the technical information that has to be submitted on the Application Form with each connection application.

4 Data submission

Data shall be submitted electronically by email using a copy of the relevant Microsoft Excel spreadsheet (for example, 'ENA Heat Pump Database Draft revXXX'), with accompanying supporting information attached to the email (see Table 1).

Table 1 – Contact Information

Contact	Energy Networks Association
Email	innovation@energynetworks.org
Telephone	+44 (0) 20 7706 5100

5 Common principles of EMC testing

5.1 General

The EMC Directive¹ applies to most manufactured products that contain electrical and electronic components. The EMC Directive covers exclusively the electromagnetic compatibility of equipment. It does not apply to 'inherently benign equipment'.

Inherently benign equipment is defined as equipment that does not generate or contribute to the electromagnetic emissions. Some examples of equipment which are inherently benign include, but not limited to,

- Cables
- Equipment containing only resistive loads that are not automatically controlled e.g. not controlled by a thermostat
- Batteries
- Electromagnetic relays without active electronic parts

It is the manufacturer's responsibility to apply the appropriate method for EMC assessment and the manufacturer shall prove compliance to the relevant EMC assessment standards.

All intended operating conditions shall be assessed in line with the EMC standards. It is the manufacturer's responsibility to declare all possible operating configurations are representative of normal use and meet the essential requirements.

The manufacturer is responsible for identifying the "worst case" configuration and shall be declared in the relevant documentation.

All HPs and EVCPs are considered to include components which require assessment against the EMC assessment standards. The EMC assessment standards that apply to any equipment that is capable of producing harmonics and that causes flicker are,

1. BS EN 61000-3-2 – Electromagnetic compatibility (EMC). Limits. Limits for harmonic current emissions (equipment input current ≤ 16 A per phase).
2. BS EN 61000-3-3 – Electromagnetic compatibility (EMC). Limits. Limitation of voltage changes, voltage fluctuations and flicker in public low-voltage supply systems, for equipment with rated current ≤ 16 A per phase and not subject to conditional connection.
3. BS EN 61000-3-11 – Electromagnetic compatibility (EMC). Limits. Limitation of voltage changes, voltage fluctuations and flicker in public low-voltage supply systems. Equipment with rated current ≤ 75 A and subject to conditional connection.
4. BS EN 61000-3-12 – Electromagnetic compatibility (EMC). Limits. Limits for harmonic currents produced by equipment connected to public low-voltage systems with input current > 16 A and ≤ 75 A per phase.

For equipment > 75 A per phase the following is relevant,

- For harmonics, data shall be determined in accordance with the requirements of BS EN 61000-3-12 or BS EN 61000-3-4 (BS EN 61851-21-2 is relevant for EVCPs). The data shall be used for an assessment in accordance with ENA EREC G5/5.
- For flicker and voltage fluctuation, data shall be determined in accordance with the requirements of BS EN 61000-3-11. The data shall be used for an assessment in accordance with ENA EREC P28.

5.2 Harmonic Assessment

Harmonics are caused by non-linear loads that affect the power quality of the network. Harmonics cause a distortion in the current and voltage waveforms. This leads to:

- Network voltage wave shape distortion
- Failures in compensation systems
- Overheating in electrical engines and transformers
- Failures in sensitive electronic devices, such as semi-conductors and power electronics
- Difficulties and abrasions in insulation levels of equipment
- Increased losses in the system
- Maloperation of the protection and control systems of electrical networks
- Increase in acoustic noise and induced noise (telephone buzzing).

Therefore, it is vital to understand the harmonic current emissions produced by the equipment to ensure minimal disruption to the network and put in place reinforcements where required.

To carry out harmonic assessments in accordance with the relevant EMC assessment standards, the basic components required are:

- 230V/400V ac power source with a low impedance (Z_s)
- Harmonic analyser
- The equipment under test (EUT)

The test circuit is shown in Figure 1 below, where:

S - power supply source consisting of,

- G open-loop voltage of the supply source
- Z_s internal impedance of the supply source

M - measurement equipment (harmonic analyser) consisting of,

- Z_M input impedance of measurement equipment

EUT - Equipment Under Test

I_h - harmonic component of order h of the line current

U - test voltage

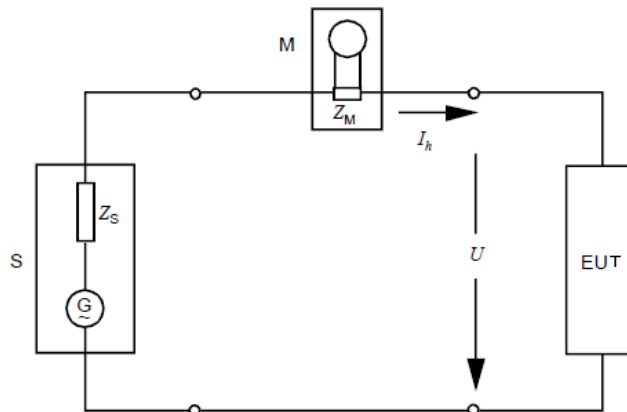

Figure 1 - Harmonic measurement circuit for single-phase equipment

BS EN 61000-3-2 requires the source voltage U to be stable to within $\pm 2\%$ of the rated voltage of the EUT and the frequency to remain stable within 0.5% of nominal. The impedance Z_M should create a voltage drop of less than 0.15V and the total impedance Z_S and Z_M should cause negligible variation in the load current.

BS EN 61000-3-2 only allows direct measurement of harmonic currents using the equipment stated above. However, BS EN 61000-3-12 provides two methods that can be used to measure harmonic currents.

1. Direct measurement
2. Calculation by valid simulation

5.2.1 Direct measurement

Typically, the direct measurement is predominantly used to measure harmonic currents.

Prior to measuring the harmonic currents, the following test conditions need to be adhered to:

- Harmonic current emission tests shall be conducted with the operation controls or automatic programs set to produce the maximum total harmonic current (THC) under normal operating conditions.
- The ambient temperature shall be at a level resulting in greater than 90% of the maximum THC under normal operating conditions.

- Or a special test mode shall be used which results in a load condition exceeding 90% of the maximum THC. This special test mode may bypass the normal control settings and allow the testing authority to operate at or near maximum rated current.
- If the above is not achievable or practical the manufacturer shall specify a test temperature that results in a THC of greater than 70% of the maximum THC.
- The temperature control shall be set to the lowest temperature in the cooling mode and to the highest temperature in the heating mode.
- The most onerous configuration shall be sought and the results declared in the test report.

In order to comply with the harmonic limits specified in BS EN 61000-3-12, the manufacturer shall choose a trial value of R_{sce} ($R_{sce\ min}$), based on the knowledge of the product design. The R_{sce} is defined as the short circuit ratio of a piece of equipment. If compliance is not achieved with the trial value $R_{sce\ min}$, a higher value of $R_{sce\ min}$ shall be chosen and the test repeated, until a value of $R_{sce\ min}$ is found that achieves compliance.

For equipment ≤ 75 A per phase, harmonic current components should be measured from the 2nd and up to the 40th harmonic order in accordance with the Note in Clause 7.3 of BS EN 61000-3-12. The manufacturer shall also declare the results for the most onerous condition.

Test conditions are described in BS EN 61000-3-12.

For equipment > 75 A per phase, harmonic currents should be measured up to the 50th harmonic order to satisfy the assessments required by ENA EREC G5/5. This also requires the device to be tested at 10% intervals of its rating to enable the discovery of the most onerous power output.

5.2.2 Calculation by valid simulation

An appropriate software modelling tool is required to simulate the harmonic emission from a device. This requires close attention to the representation of the device within the model and setting of supply characteristic parameters – this is beyond the scope of this guidance document.

5.2.3 BS EN 61000-3-2 and BS EN 61000-3-12 relationship

The harmonic limits for Class A BS EN 61000-3-2 are more onerous than BS EN 61000-3-12 and devices rated > 16 A and ≤ 75 A per phase are not expected to be compliant with BS EN 61000-3-2, BUT some may be because their harmonic emissions are low. Indeed, a proposed amendment (19/30400445) to BS EN 61000-3-12 indicates that the manufacturer can comply with the absolute limits given in BS EN 61000-3-2, Table 1, instead of the proportional limits given in BS EN 61000-3-12. Class A includes equipment such as balanced three-phase equipment, household appliances and audio equipment. The harmonic limits are a ratio of the actual harmonic current and reference current I_{ref} .

Identifying equipment as meeting the limits in BS EN 61000-3-2 has the advantage of confirming emissions are low and no detailed network study is needed for harmonics. In addition, equipment complying with BS EN 61000-3-2 are subject to an unconditional connection, and can follow the notification process i.e. connect and notify.

Equipment which is compliant with BS EN 61000-3-12 is subject to conditional connection meaning a particular impedance is required on the electricity network. The value of the impedance is dependent on the short-circuit ratio $R_{s_{ce}}$. BS EN 61000-3-12 allows different values of $R_{s_{ce}}$ to be applied during assessment. For equipment complying with BS EN 61000-3-12, it is inferred that $R_{s_{ce}} = 33$.

For equipment not complying with the harmonic current emission limits corresponding to $R_{s_{ce}} = 33$, the manufacturer shall:

- determine the minimum value of $R_{s_{ce}}$ for which the limits given are not exceeded, and;
- declare the value of the short-circuit power S_{sc} corresponding to this minimum value of $R_{s_{ce}}$ and instruct the installer to ensure that the equipment is connected only to a supply of that S_{sc} value or more.

Note: It is the DNO's responsibility to ensure the impedance value is achievable at the PCC.

5.3 Flicker and Fluctuation Testing

The current drawn from an electrical equipment can cause its voltage to change, fluctuate or flicker due to the impedance of the network. Flicker is the term used for rapid voltage fluctuations. Flicker can cause lights to change in luminance but also have an adverse effect on people's health, causing fatigue, lack of concentration, migraines and in some cases, epileptic shock. Besides the health-related issues, flicker can cause nuisance tripping of equipment because of the maloperation of control and protection circuits.

BS EN 61000-3-3 applies to equipment up to 16A per phase that is not subject to conditional connection. Compliance with the EMC Directive is a requirement for all electrical equipment that will be connected to the low voltage network.

Equipment which complies with the requirements of BS EN 61000-3-3, even if it consumes between 16A and 75A per phase, is deemed to comply with both BS EN 61000-3-3 and EN 61000-3-11 and is not subject to conditional connection.

Equipment that does not comply with the limits in BS EN 61000-3-3 must be declared compliant with BS EN 61000-3-11 and be subject to conditional connection.

BS EN 61000-3-3 declares the reference impedance to be used when measuring the voltage fluctuations at the supply terminals of the equipment under test.

Single Phase $Z_{ref} = 0.4 + j0.25 \Omega$

Split Phase $Z_{ref} = 0.48 + j0.3 \Omega$

Three Phase $Z_{ref} = 0.24 + j0.15 \Omega$

The voltage fluctuations are then analysed for comparison to the limits. The limits are placed on three factors:

- The relative voltage change (maximum d_{max} and steady-state d_c)
- The short-term flicker value P_{st}
- The long-term flicker value P_{lt}

Table 2 – Limits of voltage fluctuations and flicker

	P_{st}	P_{lt}	$d(t)$	d_c	d_{max}
Limit	1	0.65	3.3% for more than 500ms	3.3%	4% without additional conditions 6% for equipment switched manually or switched automatically more than twice a day

Note: P_{st} and P_{lt} do not apply to manual switching or voltage fluctuations occurring less frequently than once per hour. However, the d_{max} and d_c does apply for such occasional events and this places a limit on the allowable switch-on inrush current for any equipment.

The manufacturer has two options for specifying conditional connection,

1. Determine and declare the maximum permissible system impedance Z_{max} at the supply terminals of the user's supply i.e. at the 'cut-out'. This is done by calculating the a.c. supply system impedance that would be required for the equipment's current fluctuations to cause voltage fluctuations that met the limits. This is based on knowing the values of various tested parameters when tested with one system impedance and using that information to calculate the impedance that would be required to actually meet the limits.
2. Test the equipment as is done for BS EN 61000-3-3 but with a lower a.c. supply system impedance and declare that the equipment is intended for use only in premises having a service current capacity of $\geq 100A$ per phase, which equates to:

$$\text{Single Phase} \quad Z_{max} = 0.25 + j0.25 \, \Omega = 0.354 \, \Omega$$

$$\text{Three Phase} \quad Z_{max} = 0.15 + j0.15 \, \Omega = 0.212 \, \Omega$$

Fluctuation and flicker can be measured directly or calculated.

5.3.1 Direct measurement

To carry out fluctuation and flicker tests in accordance with the relevant EMC standards, the basic instrumentation is essentially the same as the harmonic analyser used for testing to BS EN 61000-3-2 and therefore the harmonics and flicker analysers are often packaged together.

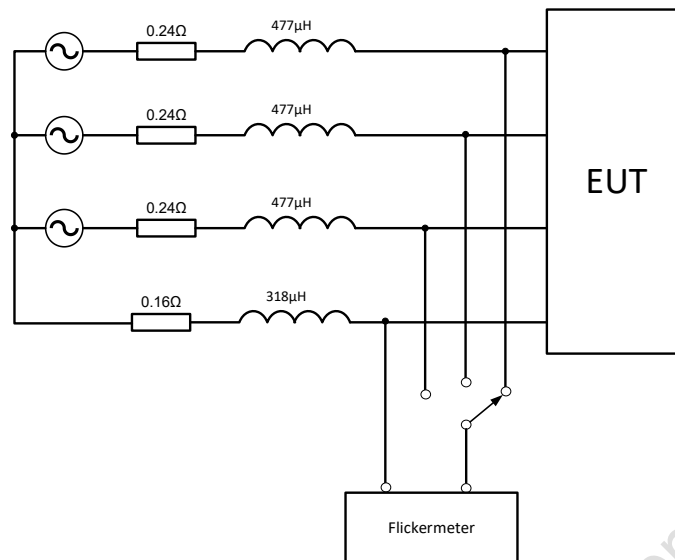

Figure 2 - Voltage fluctuations and flicker measurement circuit

5.3.2 Calculating flicker and fluctuation

To calculate flicker and fluctuation, the maximum voltage change d_{max} needs to be determined (difference between the maximum and minimum r.m.s voltage change). To calculate d_{max} , knowledge of the system power rating, starting current, form factor and starting sequence are required. For each start/step, the maximum voltage change is determined. The highest value of d_{max} from the sequence is then chosen. This d_{max} value is used to calculate short-term flicker P_{st} . The long-term flicker P_{lt} is calculated using successive values of P_{st} .

If the values of either d_{max} , P_{st} and P_{lt} are above the limits stated in Table 2 then the manufacturer should re-test using a lower test impedance Z_{test} .

For a single-phase equipment,

$$Z_{test} = 0.25 + j0.25 \Omega = 0.354 \Omega$$

For three phase equipment,

$$Z_{test} = 0.15 + j0.15 \Omega = 0.212 \Omega$$

If the values of d_{max} , P_{st} and P_{lt} are within the limits using the lower impedance, the manufacturer shall declare compliance to BS EN 61000-3-11 but state the service capacity required has to be greater than or equal to 100A per phase.

If the values of d_{max} , P_{st} and P_{lt} are above the limits using the lower impedance, the manufacturer shall then determine and declare the maximum permissible system impedance Z_{max} at the supply terminals of the user's supply.

5.3.3 BS EN 61000-3-3 and BS EN 61000-3-11 relationship

BS EN 61000-3-11 is a companion standard to BS EN 61000-3-3 and uses the same tested parameters and flickermeter. However, BS EN 61000-3-11 applies to equipment that require a conditional connection.

6 Heat Pump Systems

6.1 Overview of typical systems

A heat pump can operate in many different configurations. The table below summarises typical heat pump systems that are installed.

Table 3 – Typical heat pump systems

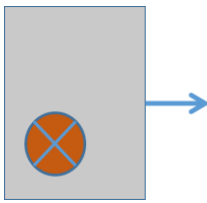
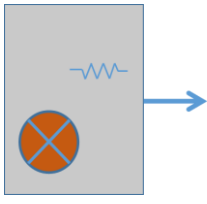
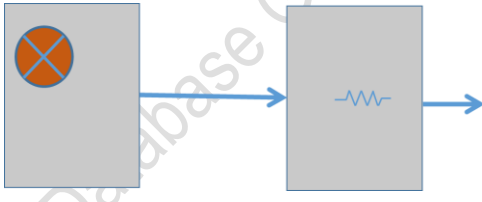
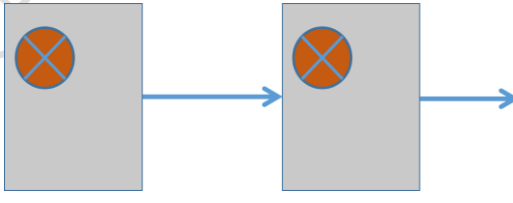
Configuration	Schematic	Description
Heat pump only		A simple heat pump unit with no additional heating elements.
Heat pump + 'onboard' associated DERH		A heat pump with an onboard DERH that can provide additional heating when required. Both the heat pump and DERH are tested together as a whole system.
Heating pump + 'external' associated DERH		A heat pump that makes use of an external DERH. The external DERH may be tested with the heat pump or tested individually.
Outdoor heat pump and indoor heat pump		Two heat pumps that are connected together but make use of two different refrigerants.

6.2 Terms and Definitions

6.2.1

direct electric resistance heater (DERH)

6.2.1.1

associated DERH

module which is configured as part of the **heat pump system** design or system installation and may be located either internally or externally to the heat pump module.

6.2.1.2

replacement heater

DERH that is capable of replacing all or some of the heat output from the heat pump in the event of the heat pump not being operational. This type of heater will only operate in the event of heat pump failure.

6.2.1.3

water heater or 'immersion heater'

DERH located in the domestic hot water cylinder and used to top-up heat from the heat pump

6.2.2

heat pump system

heat pump technology, including all **associated DERH** where applicable, that is installed and operated under a single controller

6.2.3

Rated power (S_{equ})

input power of the piece of equipment as declared by the manufacturer and marked as such on the rating plate of the piece of equipment or stated in the product documents

6.3 Heat Pump spreadsheet for data submissions

The spreadsheet for data submissions comprises the following Worksheets:

- A1 Summary Data worksheet
- A2 Data $\leq 16A$ worksheet
- A3 Data $\leq 75A$ – harmonics worksheet
- A4 Data $\leq 75A$ (d, e, f) – harmonics worksheet²
- A5 Data $> 75A$ – harmonics worksheet
- A6 Data $\leq 75A$ – fluctuations worksheet
- A7 Data $> 75A$ – fluctuations worksheet
- A8 Data $> 16A$ – harmonics worksheet³

Data descriptions for each data field are provided in Tables A1-A8 of Annex A.

The flowchart in Figure 3 illustrates which worksheets to complete based on equipment rating.

The data for heat pump systems provided by manufacturers may relate to the whole system or one or more parts/modules of the system. Worksheet A1 has a drop-down list in column O to enable summary data to be entered for each module in a separate row. Worksheets A2 to

² This sheet is provided for equipment types meeting Table 5 specified conditions (d), (e) and (f) in BS EN 61000-3-12.

³ This sheet is provided for use in conjunction with sheet A3 and A4 to provide data in support of the claim for connection design purposes of compliance with the Class A emission limits of BS EN 61000-3-2 despite the equipment being out of scope of that standard.

A8 are for provision of supporting data; it may be necessary to replicate one or more of these worksheets so that the supporting data for each module can be provided.

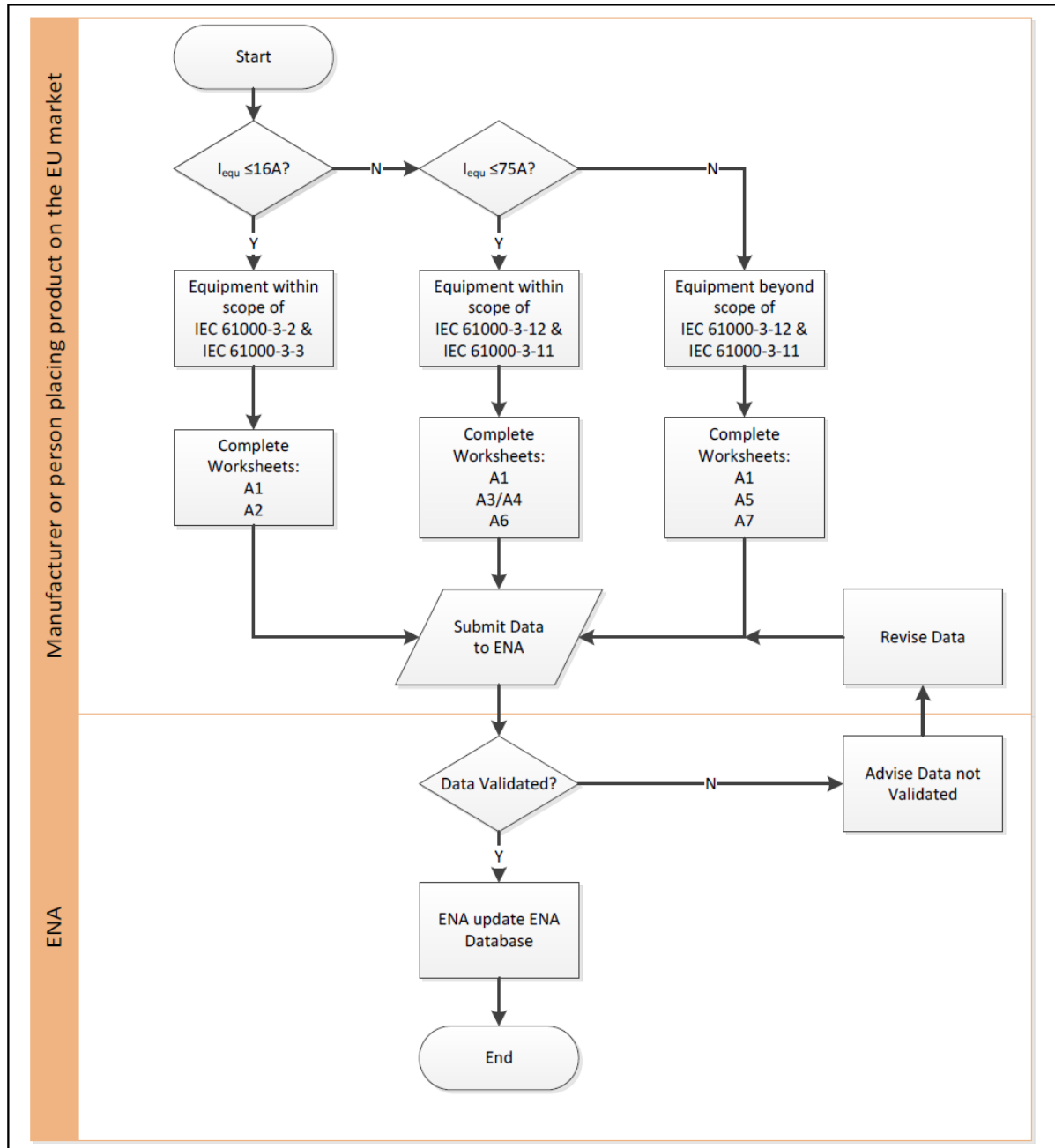

NOTE: IEC 61000-3-2/12 are the same as BS EN 61000-3-2/12. Likewise, IEC 61000-3-3/11 are the same as BS EN 61000-3/11.

Figure 3 - Heat Pump data submission process

6.4 Different Modes of Operation (Heating only, Heating and Cooling)

6.4.1 General

Heat pumps can be installed to operate in either heating mode, or heating and cooling modes. A heat pump system that could be installed as “heating only” and “heat and cooling” will require separate submissions by the heat pump manufacturer.

NOTE: The test report shall include all harmonic and fluctuation/flicker data for all modes being considered to enable the most onerous emissions to be declared on the submission.

When compiling the data for such submissions there are a number of pertinent considerations which are described below.

6.4.2 Current ratings and emissions

In the Summary Sheet A1, the rated current for each load shall be entered. The value entered shall be as declared by the manufacturer and marked as such on the rating plate of the piece of equipment, or as stated in the product documents. The maximum current demand may differ from the rated current demand, as it may reflect current demand of the system under extreme conditions. Where the maximum current demand differs from the rated current it should be stated. Figure 4 shows a typical display of rating information for a heat pump.

The linear and non-linear load should be separately identified so the host DNO can determine the connection requirement appropriately i.e. the connection requirement can be determined for the non-linear load only.

NOTE 1: Depending on the design of the heat pump system, the total rated current for the system is typically the sum of all the modules rated currents. Where a module is interlocked with another, the current rating is not the sum of the modules, rather the rating of the module with the highest current draw.

Figure 4 – Example of rated current as declared in an EMC test report

Type	Type Designation:	[Redacted]
Power supply 1 (Heat Pump)	Rated Voltage	230V~ 1φ 50Hz
	Current / Power	29.0A / 6.27kW

Figure 5 – Example of rated current entered in the Summary Sheet A1

Heat Pump Type Register Number	Make	Model	Module	Module Input Rated Current (A)
[Redacted]	[Redacted]	[Redacted]	Heat pump	29.00
			Back-up heater - on-board	26.00

For devices rated above 16 A and below 75 A, harmonic emission data shall be entered in Sheet A3 (Sheet A4 required in special cases). In Sheet A3, two particular values of current required are defined in BS EN 61000-3-12 as follows:

- I_{equ} “Input current of the piece of equipment as declared by the manufacturer and marked as such on the rating plate of the piece of equipment or stated in the product documents”

This value (I_{equ}) is typically the rated current for the module as entered in Sheet A1. However, I_{equ} may differ (be lower) from the rated current due to the particular operating mode for the device.

- I_{ref} “value of the r.m.s. input current of the equipment determined according to 4.1 and used to establish emission limits”

The reference current I_{ref} shall be determined during the test and stated in the EMC report.

Considering an example, the value of I_{equ} is declared in the EMC test report and is dependent on the mode of operation i.e. a heat pump for different modes of operation may have different I_{equ} values. The EMC report will provide harmonic emission data for all modes of operation being considered. The data to be captured in the submission shall be the most onerous emission data associated with relevant modes of operation.

Where the value of I_{equ} and I_{ref} differ, the manufacturer should include a note to explain the difference. For example, the most onerous condition may not be at the rated current I_{equ} or the I_{ref} used may be due to the limit of the testing device.

Figures 6 and 7 show the I_{equ} values for a heat pump with a cooling mode and heating mode which are 17.24 A and 17.45 A respectively.

NOTE 2: The most onerous mode of operation for harmonics is not necessarily the mode with the highest current draw, but rather the mode with the highest current values for each harmonic order. The percentage harmonic current is affected by I_{ref} (a smaller I_{ref} increases the percentage vales).

Figure 6 – Example of I_{equ} for Cooling

Item	R _{sce}	Remarks	Calculation:		
I ₃	113.2957		THD(%)	=	30.686
I ₅	69.1941		$I_{equ} = I_1 \times (1 + THD^2)^{1/2}$	=	17.24 A
I ₇	-183.4553		U _p (rated voltage)	=	230.00 V
I ₉	99.1635		S _{equ} = U _p X I _{equ}	=	3964.60 W
I ₁₁	-103.7263				
I ₁₃	67.2817		S _{sc} = R _{sce} X (3 X S _{equ})	=	1536031.21 W
THD	129.1455	Max selected	(Additional 10% + rounded	□	1700 kW
PWHD	-150.1186		To nearest 50kW)		

Figure 7 – Example of I_{equ} for Heating

Item	R _{sce}	Remarks	Calculation:		
I ₃	110.3326		THD(%)	=	30.435
I ₅	65.3072		$I_{equ} = I_1 \times (1+THD^2)^{1/2}$	=	17.45 A
I ₇	-183.5631		U _p (rated voltage)	=	230.00 V
I ₉	95.1321		S _{equ} = U _p X I _{equ}	=	4014.47 W
I ₁₁	-105.0434				
I ₁₃	65.0560		S _{sc} = R _{sce} X (3 X S _{equ})	=	1515065.27 W
THD	125.8002	Max selected	(Additional 10% + rounded	□	1650 kW
PWHD	-151.4482		To nearest 50kW)		

Therefore, having determined the most onerous emissions for each mode, the value in cell D38 of Sheet A3 (I_{equ}) for the heating & cooling mode shall be equal to 17.24 A, and for the heating only mode shall be equal to 17.45 A.

Figure 8 – Capturing I_{equ} from Figure 6 and Figure 7

Phase	L1
Current (A)	
I_{equ}	17.24

Phase	L1
Current (A)	
I_{equ}	17.45

Similarly, for the reference current, the heating & cooling mode shall be equal to 16.479 A, and 16.698 A for the heating only mode, as described in the EMC test report. This shall be entered into cell D39 Sheet A3 (I_{ref}) for the two separate submissions.

Reference current, I_{ref} : 16.698A (Heating), 16.479A (Cooling)

I_{ref}	16.479
-----------	--------

I_{ref}	16.698
-----------	--------

The third and last value of current required in Sheet A3 (cell D42) is the 'RMS' current, which is defined in BS EN 61000-3-12 as:

I_{RMS} "The manufacturer may specify any value of r.m.s. current which is within $\pm 10\%$ of the actual measured value and use it as the reference current for the original manufacturer's conformity assessment test."

The RMS current value is normally ascertained by reviewing the EMC test report: it is typically stated within the harmonic current values table as the fundamental (order 1) harmonic value.

Figure 9 - Example of RMS Current for different modes

Average harmonic current results			Harmonic current results - DS: 1716		
H _n	I _{eff} [A]	I _{eff} [%]	H _n	I _{eff} [A]	I _{eff} [%]
1	15.689	95.206	1	15.826	94.777

	Current (A)	I _n /I _{ref} (%)		Current (A)	I _n /I _{ref} (%)
RMS	15.689	95.21	RMS	15.826	94.78

Having captured I_{equ}, I_{ref} and I_{RMS} current values, the last requirement is to provide individual harmonic values. The individual harmonic values shall be from the 2nd up to and including the 40th harmonic, or up to and including the 50th harmonic, if possible, for each of the operating modes. At this point, the data submission requirements will have been met.

6.5 Heat Pumps with associated DERH

The system may consist of a heat pump and associated direct electric resistance heater (DERH), which may or may not be powered separately, together forming the heating circuit and operated by one control system.

The manufacturer shall declare, in the documentation, the switching stages of the heating elements i.e. switched ON in stages or in one 'lump' or if the load is spread across multiple phases.

A controlled DERH module (switched on/off automatically) would generally fall under the requirements of the EMC Directive. Hence, the manufacturer would be required to provide reference to the technical documentation demonstrating evidence of compliance.

A typical example of a DERH module is a heater which replaces all or some of the heat output from the heat pump in the event of the heat pump not being operational.

Where modules (heat pump and DERH) are designed to normally operate simultaneously and there is a possibility of the disturbances from each module being additive, these modules should be treated as a whole and tested/assessed as such. Attention is drawn to the wording of Schedule 1 to the EMC Regulations 2016 (SI 2016 no.1091):

3. The electromagnetic compatibility assessment must take into account all normal intended operating conditions. Where the apparatus is capable of taking different configurations, the electromagnetic compatibility assessment must confirm whether the apparatus meets the essential requirements set out in paragraph 1 of Schedule 1 in all the possible configurations identified by the manufacturer as representative of its intended use.

Where it is demonstrated that modules do not operate simultaneously with no additive disturbances, there may be separate testing/assessment i.e. one EMC report for the heat pump and one EMC report for the DERH.

The test/assessment data for modules considered separately shall be entered in the appropriate template i.e. separate lines used for each module. In Summary Sheet A1, the

rating details for the total system and for each module are captured as shown in the example in Figure 10. Each module will have its own rated current (determined as described in Section 6.4.2) and the total maximum system demand should be entered as the sum of the individual modules, unless modules are interlocked (refer to NOTE in Section 6.4.1).

Figure 10 - Example of a Split heat pump system in Summary Sheet A1

Total Heat Pump System Maximum Demand (A)	Total Heat Pump System Maximum Demand (kVA)	Module	Module Input Rated Current (A)	Module Input Rated Power (kVA)
38.40	8.83	Heat pump	14.90	3.43
		Back-up heater	23.50	5.40

The declaration of conformity can either be declared for both modules in one document or declared individually.

Based on the module rated current, the appropriate harmonic and voltage fluctuation/flicker standards shall be referenced in the submission data and the relevant data provided.

Therefore:

- a) For modules < 16A, Sheet A2 shall be completed
- b) For modules rated > 16A, Sheets A3 (<75A Harmonics) and A6 (<75A Fluctuations) shall be completed.
- c) For modules rated > 16A but satisfying BS EN 61000-3-2 Class A limits, Sheets A3 (<75A Harmonics), A6 (<75 Fluctuations) and Sheet A8 shall be completed (see Section 6.6).

It is normally expected that there are very little harmonics associated with a DERH module – this would be confirmed during the submission of data. Therefore, harmonic data is not applicable and the module may be listed as satisfying the requirements of BS EN 61000-3-2 – see Figure 11. However, some DERH modules may be controlled by power electronics in which case there may be relevant harmonic data.

Figure 11 - Compliance with EN 61000-3-2 with rated current > 16A

Module	Module Input Rated Current (A)	Module Input Rated Power (kVA)	Standards Cited on CE Declaration of Conformity	
			Harmonic Standards	Voltage Fluctuation/ Flicker Standards
Heat pump	14.90	3.43	EN 61000-3-2	EN 61000-3-3
Back-up heater	23.50	5.40	EN 61000-3-2	EN 61000-3-11

A typical submission for a system consisting of a heat pump > 16A and a DERH > 16A, would be; Sheets A1, A3 (for the heat pump) and A6 (one for the heat pump and one for the DERH).

6.6 Heat Pump Systems > 16 A, but compliant with BS EN 61000-3-2 and BS EN 61000-3-3

6.6.1 General

In general, heat pumps >16A fall outside of the scope of the BS EN 61000-3-2 standard. However, some larger heat pump systems (> 16A) may satisfy the Class A limits in BS EN 61000-3-2. If the heat pump system has a total system (input) current (rated and/or maximum) less than 32A and compliance to both BS EN 61000-3-2 Class A limits and BS EN 61000-3-3 requirements are satisfied, the heat pump can be listed as 'Connect & Notify' on the database.

6.6.2 Demonstrating Class A limits in BS EN 61000-3-2 are satisfied

To validate if the heat pump complies with BS EN 61000-3-2 Class A limits, the average and maximum harmonic currents up to and including the 40th harmonic are required. The current values shall be included in Sheet A8.

NOTE: In accordance with Clause 6.3.3.4 of BS EN 61000-3-2, it is acceptable for some current harmonic values to exceed the limits as defined in Table 1 of the standard.

A typical example is shown in Figure 12.

Figure 12 - Example of a Heat Pump > 16A which complies with BS EN 61000-3-2 Class A limits

h	Class A Limit	Heating Ave. Emission (A)	Max. Ave. Emission (A)	Compliant 100% Limit?	Heating Max Emission (A)	Compliant 150% Limit?
2	1.08	0.2245	0.2245	YES	0.2268	YES
3	2.3	0.2764	0.2764	YES	0.2834	YES
4	0.43	0.0957	0.0957	YES	0.097	YES
5	1.14	0.2248	0.2248	YES	0.2278	YES
6	0.3	0.0503	0.0503	YES	0.0513	YES
7	0.77	0.1242	0.1242	YES	0.1264	YES
8	0.23	0.0349	0.0349	YES	0.0359	YES
9	0.4	0.1029	0.1029	YES	0.1043	YES
10	0.184	0.0234	0.0234	YES	0.0246	YES
11	0.33	0.0743	0.0743	YES	0.0767	YES
12	0.153333333	0.0189	0.0189	YES	0.0202	YES
13	0.21	0.0164	0.0164	YES	0.02	YES
14	0.131428571	0.0146	0.0146	YES	0.016	YES
15	0.15	0.0258	0.0258	YES	0.0279	YES
16	0.115	0.0119	0.0119	YES	0.0136	YES
17	0.132352941	0.0286	0.0286	YES	0.0307	YES
18	0.102222222	0.0098	0.0098	YES	0.0118	YES
19	0.118421053	0.016	0.016	YES	0.0181	YES
20	0.092	0.0092	0.0092	YES	0.0107	YES
21	0.107142857	0.0327	0.0327	YES	0.0349	YES
22	0.083636364	0.0097	0.0097	YES	0.0107	YES
23	0.097826087	0.0419	0.0419	YES	0.0436	YES
24	0.076666667	0.01	0.01	YES	0.0115	YES
25	0.09	0.0365	0.0365	YES	0.0392	YES
26	0.070769231	0.013	0.013	YES	0.0156	YES
27	0.083333333	0.0592	0.0592	YES	0.0616	YES
28	0.065714286	0.015	0.015	YES	0.017	YES
29	0.077586207	0.0628	0.0628	YES	0.0659	YES
30	0.061333333	0.0131	0.0131	YES	0.0156	YES
31	0.072580645	0.0661	0.0661	YES	0.069	YES
32	0.0575	0.0121	0.0121	YES	0.0133	YES
33	0.068181818	0.0662	0.0662	YES	0.0687	YES
34	0.054117647	0.0119	0.0119	YES	0.0135	YES
35	0.064285714	0.0519	0.0519	YES	0.0541	YES
36	0.051111111	0.0119	0.0119	YES	0.014	YES
37	0.060810811	0.0522	0.0522	YES	0.0544	YES
38	0.048421053	0.0109	0.0109	YES	0.0122	YES
39	0.057692308	0.0432	0.0432	YES	0.0452	YES
40	0.046	0.0087	0.0087	YES	0.0104	YES

6.6.3 Demonstrating that the requirements of BS EN 61000-3-3 are satisfied.

When declaring conformance to the requirements of BS EN 61000-3-3, the important requirement is to have tested the device with the appropriate impedance. This test impedance shall be declared in the manufacturer's documentation to assist with compliance checks.

In accordance with BS EN 61000-3-3, the reference impedance for:

- a single-phase system shall be $Z_{ref} = 0.4 + j0.25 \Omega$;
- a split-phase system shall be $Z_{ref} = 0.48 + j0.3 \Omega$;
- a three-phase system shall be $Z_{ref} = 0.24 + j0.15 \Omega$.

If the reference impedance used during the type test is less than that stated in BS EN 61000-3-3, the maximum impedance applicable shall be declared in accordance with BS EN 61000-3-11.

6.7 Heat pump submissions where EMC flicker test data is incomplete

In cases where heat pump voltage fluctuation data for validating conformance to BS EN 61000-3-3/11 is either incomplete or not substantive, an ENA EREC P28 Stage 2 assessment may be undertaken by the host DNO and the Heat Pump placed on the ENA database.

It is important that a DNO is engaged to undertake the ENA EREC P28 Stage 2 assessment i.e. the heat pump manufacturer shall liaise with the most relevant DNO for the connection(s) being considered.

In doing an ENA EREC P28 Stage 2 assessment, the DNO will undertake a network study using relevant tools e.g. WinDebut. The flicker limits prescribed in EREC P28 for a Stage 2 shall be applied.

The following minimum information is required from the manufacturer:

- Equipment manufacturer and model
- Number of connected phases e.g. 1,2,3,
- Whole system rating in kW (input) i.e. compressor plus any back-up and/or boost heating elements
- Compressor motor rating in kW (input) e.g. 5 kW
- Starting method e.g. direct-on-line (DOL) or Soft Start (Inverter driven)

Unless the manufacturer provides sufficient details of the starting current (motor start curve), the DNO shall assume that:

- for soft start the starting current is 2.5 times the rated current
- for DOL the starting current is 7.5 times the rated current
- Maximum number of starts per hour
- Rating of back-up heating element(s) e.g. 3kW or 3kW (an option to disable may be used)
- Number of switches to energise the back-up heating element(s) e.g. 1 or 2
- If there are multiple heating elements, do they start sequentially?

- NOTE: if there are multiple heating elements that start sequentially, it is worth providing kW (input) rating for each element (if different from one another) – for example, 2 heating elements; one rated at 3kW and the other 6kW. 1 x 3kW (On or Off)

The host DNO shall determine the maximum impedance of the connection (between the point of common coupling and the cut-out) to ensure that the limits prescribed by EREC P28 for a Stage 2 assessment are satisfied.

Where multiple motors are used, the number of starts per hour should be assumed to be the summation of the number of starts of both motors e.g. 2 motors starting 6 times each. In this case the DNO should model one motor for flicker but the number of starts is set at 12 to provide the correct maximum voltage change associated with the $P_{st} = 0.5$ curve.

The DNO should make the following assumptions with regards to harmonic emissions:

- a) Where the motor has a DOL starting method, it may be assumed that the device complies with BS EN 61000-3-2 Class A emission limits.
- b) Where the device has a soft starting motor or a variable speed drive, it may be assumed that the motor complies with the emissions limits in BS EN 61000-3-12 for an R_{scc} of 33.

7 EV Charge Points

There are two predominant categories of EV Charge Point (EVCP) technologies:

- a) AC charger – this type of charger is typically single-phase or three-phase, 230 V/400 V a.c. and have a rating of 16 A (3.6 kW – 11.1 kW) or 32 A (7.4 kW – 22 kW) at unity power factor.
- b) DC charger – this type of charger has a typical power rating of 50 kW – 150 kW.

NOTE: EVCPs which have a generation functionality i.e. V2G, are outside the scope of this guidance document. V2G EVCP devices must be installed, commissioned and fully type tested in accordance with EREC G98 or EREC G99 (whichever is applicable).

The information required for an EVCP is dependent on whether it is an AC device, or a DC device.

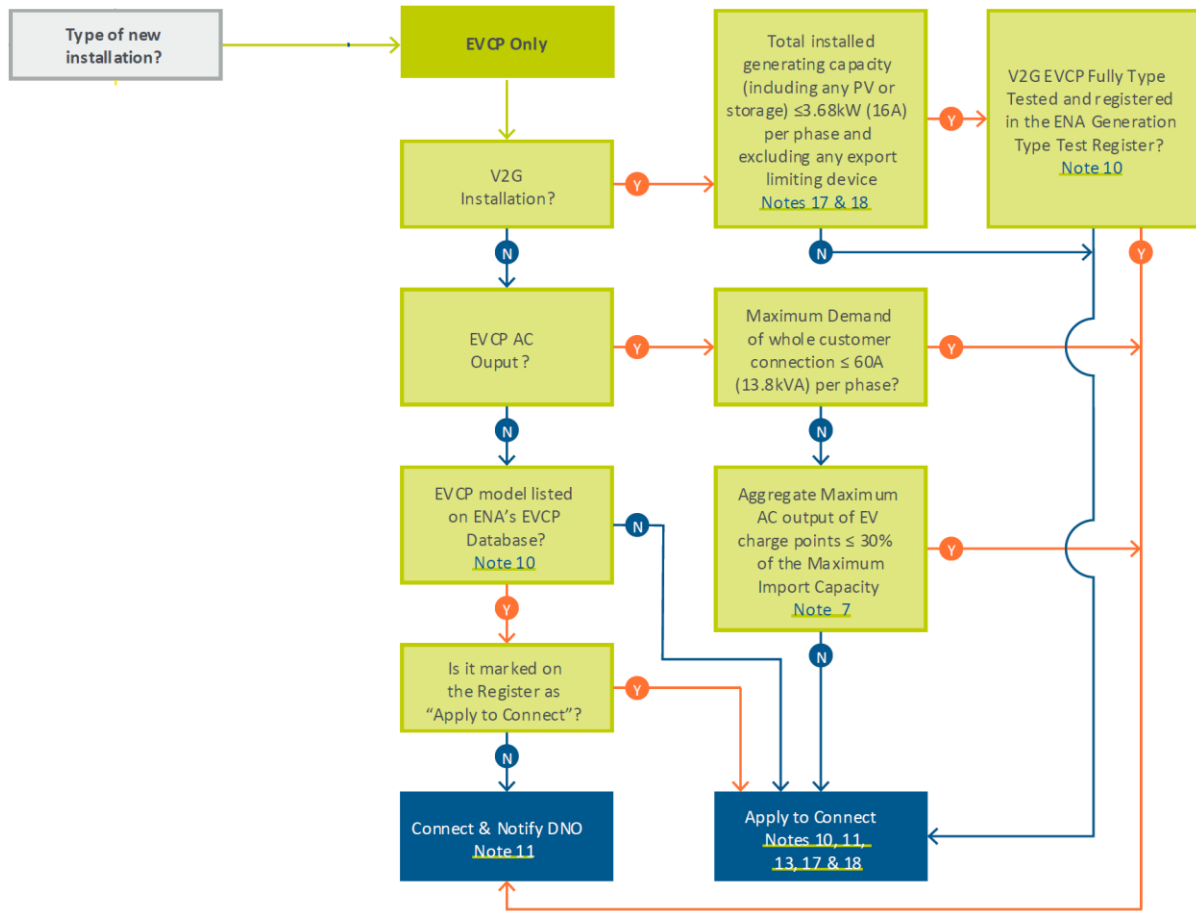

7.1 AC EV Charge Points

Key points:

- In accordance with the ENA HP and EVCP process⁴, the assessment of AC EVCP power quality is generally not required.
- ENA ETR 122 Issue 2 shall be used to qualify the satisfaction of EREC G5 Issue 5 (G5/5).

The minimum information required for an AC EV Charge Point is:

1. EVCP model information (e.g., model number & output type).
2. Rated current and power.
3. Barcode or product code.

⁴ <https://www.energynetworks.org/industry-hub/resource-library/low-carbon-technologies-combined-installation-process-flow-chart.pdf>

7.2 DC EV Charge Points

Key points:

- Equipment rated $\leq 75A$ is assessed against product standards (EN 61000-3-3, 61000-3-11, 61000-3-2, 61000-3-12) as mentioned in earlier part of this document.
- For equipment rated $>75A$, there is a need for sufficient data to be provided to allow connection design to control potential power quality disturbance and ensure compliance with the Distribution Code. The Distribution Code of Great Britain technical requirements include adherence to the following:
 - EREC P28/2 'Voltage fluctuations and the connection of disturbing equipment to transmission systems and distribution networks in the United Kingdom'.
 - EREC G5/5 'Harmonic voltage distortion and the connection of harmonic sources and/or resonant plant to transmission systems and distribution networks in the United Kingdom'.
 - EREC P29 'Planning limits for voltage unbalance in the UK for 132 kV and below'.

The minimum information required for an DC EV Charge Point is:

1. EVCP model information (e.g., model number & output type).
2. Rated current and power.

The device to be connected would either be three-phase or single-phase. If the device is a three-phase device that may be connected to a single-phase supply, it shall be listed separately.

3. Barcode or Product.

This shall be a unique identifier for a specific model of EV charge point. The barcode or product code shall be readable via a scanning device which shall enable the identify the EV CP make and model to be determined.

4. Harmonic emission assessment.

Equipment rated $\leq 75A$ is assessed against product standards i.e. EN 61000-3-2, and 61000-3-12, for harmonics, as mentioned in earlier part of this document.

EREC G5/5 sets the criteria for assessment of disturbing load in 3 stages.

Connection assessments for LV equipment greater than 75 A falls under: Stage 1C, Stage 1D, or Stage 2C. The Stage 2C assessment is the most refined approach and avoids 'worse case' assumptions – to do this the actual harmonic current emissions for the equipment are required. The harmonics emission at the worst power level (10% to 100%) are needed. The following standards are relevant for the harmonic emissions test approach: BS EN 61851-21-2, IEC 61000-3-4.

5. Confirmation of satisfactory voltage fluctuation/flicker performance

For voltage fluctuations and flicker there is no standard in force for rated current above 75A. However, the maximum source impedance, Z_{max} , derived using the

methodology employed in EN 61000-3-11 is useful information for DNOs. Furthermore, EN 61000-3-3 provides an analytical method for calculating flicker which can be used to derive a Z_{\max} value.

6. Declaration of Conformity stating EMC standards compliance with EN 61000-3-12 if the device is less than 75A or it complies with EN 61000-3-12 with a minimum short circuit power requirement. If the device is greater than 75A, a stage 2C assessment of EREC G5/5 shall be required.

ENA HP & EVCP Database Guide Document v5 Issued